



WWW40-P

[User Manual]

Please read and follow the installation and operating instructions provided.

Table of Contents

- I. Introduction 1
- II. Installation Instructions 2
 - Step #1 Lay out your frame
 - Step #2 Connect Left and Right Frame to Hitch
 - Step #3 Connect your toolbar
 - Step #4 Connect Your Wings
 - Step #5 Attach your Wing Brace
 - Step #6 Insert the Wheels
 - Step #7 Attach your Stabilizer Bar
 - Step #8 Attach the Tank
 - Step #9 Connecting the Sponges
 - Step #10 Attaching your boom
 - Step #11 Plumbing and Manifold options
 - Step #12 Connect Your Wiper to Your Hitch
 - Step #13 Using the wiper with your sprayer and installing the electrical wire harness
- III. Operating Instructions10
 - Before You Start
 - Mixing Instructions
 - Field Adjustments
- IV. Maintenance Requirements.....12
 - Common Filter Maintenance
 - Operating At Freezing Temperatures
- V. Policies and Information13

IMPORTANT:

**PLEASE RETURN YOUR OWNERS REGISTRATION CARD WITHIN THE NEXT 10 DAYS TO
ACTIVATE YOUR WARRANTY.**

INTRODUCTION

Congratulations on your purchase of a Smucker Super Sponge® Weed Wiper!

The Super Sponge® is a lightweight, durable, herbicide applicator. Our sponges are designed to apply the maximum amount of product to the target weeds without any drift. The sponge applicators are made of industrial-strength, crusted sponge that stay saturated with chemical to wipe directly onto weeds. Our sponge weed wiper and top crop kits are applicators. Smucker Manufacturing makes no guarantee of any and all chemical use through the sponge application. Please read all chemical labeling concerning the weed wiper instructions.

The Super Sponge® has proven to be a quick and efficient way to wipe out weeds in your crops in many independent studies and we are confident you will be pleased with the results. We value our customers, and we would appreciate any input or comments you may have regarding your new Super Sponge® wiper.

You will find a Smucker Catalog with all of the replacement parts and diagrams included in the Weed Wiper section of the catalog. You can also visit our smuckermfg.net website page for weed wiper parts information, to find out which part you need. If you still have questions, give us a call and we can even help you locate your closest Smucker dealer.

Also, visit www.smuckermfg.net or ask your dealer about the other product lines we offer. We offer premium products at an affordable price. Take a look at our Foam Markers, Calf Warmers, and VisionWorks camera systems for farm equipment on our website.

www.smuckermfg.net

www.redweeder.com

www.visionworkscameras.com

Scan QR codes below with your smart phone

Mobile website for VisionWorks Cameras

Smucker Mobile website



Installation Instructions

Thank you for purchasing a Pull-Type Weed Wiper kit. Please follow the directions provided carefully. We recommend installing this unit with two people, and you should expect around 1-1 ½ hours of installation.

Please refer to your Parts Inventory Sheet when installing your Weed Wiper.

Step #1 Lay out your frame

Lay out your frame on the ground in conjunction to the image below. This will be your finished product.



Don't worry, we will explain the steps below. This picture is only for your visual reference.

Step #2 Connect Left and Right Frame to Hitch

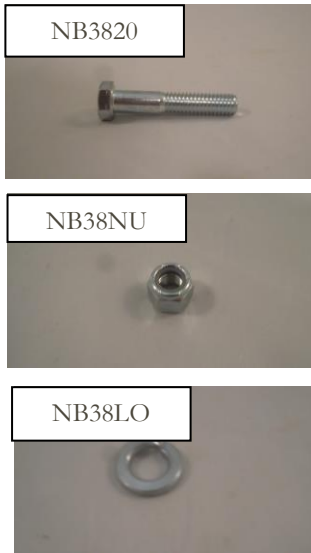

Insert your main frame left and main frame right into the tank and hitch stand assembly. Make sure to secure your brackets in so that the wheel brackets are sticking up (as pictured). Secure your frame members with the 3/8" x 2" bolts provided (NB3820 QTY: 4) with the 3/8" lock washers (NB38LO QTY: 4) and 3/8" nuts (NB38NU QTY: 4) provided.

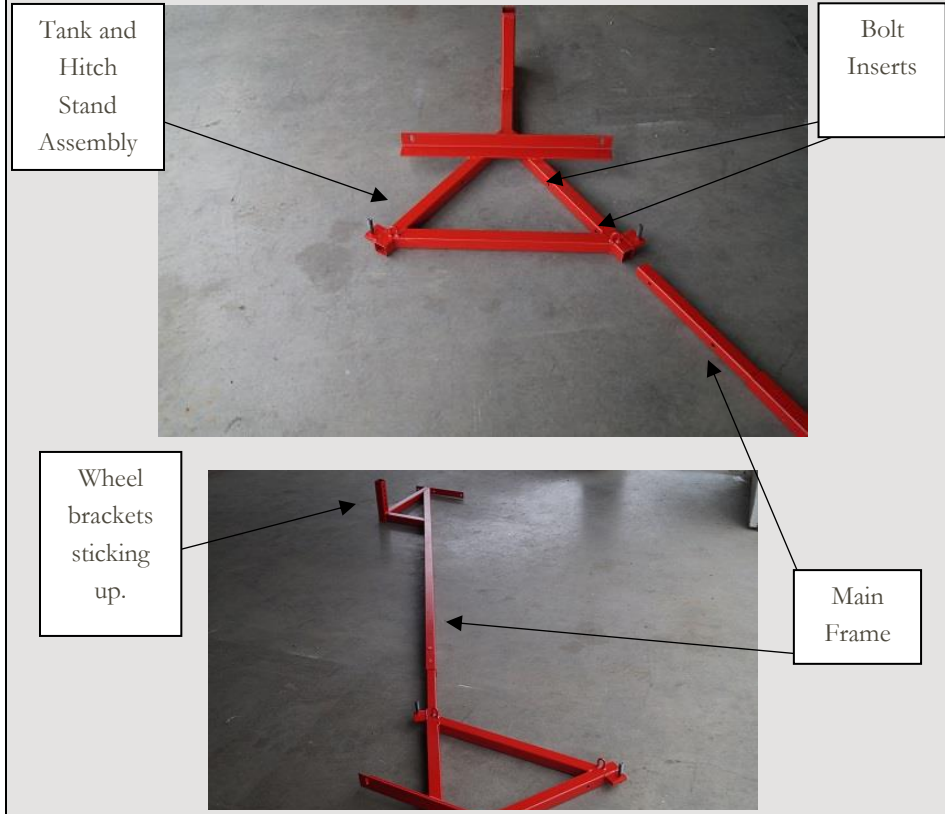

Step #3 Connect your toolbar



Bolt your rear tool bar to the back of your left frame and your right frame with 3/8" x 3" (NB3830 QTY: 6) bolts (with the 3/8" lock washers (NB38LO QTY: 6) & 3/8" nuts (NB38NU QTY: 6)) on **each side** using the inside holes. Make sure that the angled iron brackets pictured below are facing toward the front of your weed wiper model (i.e. towards the front hitch).

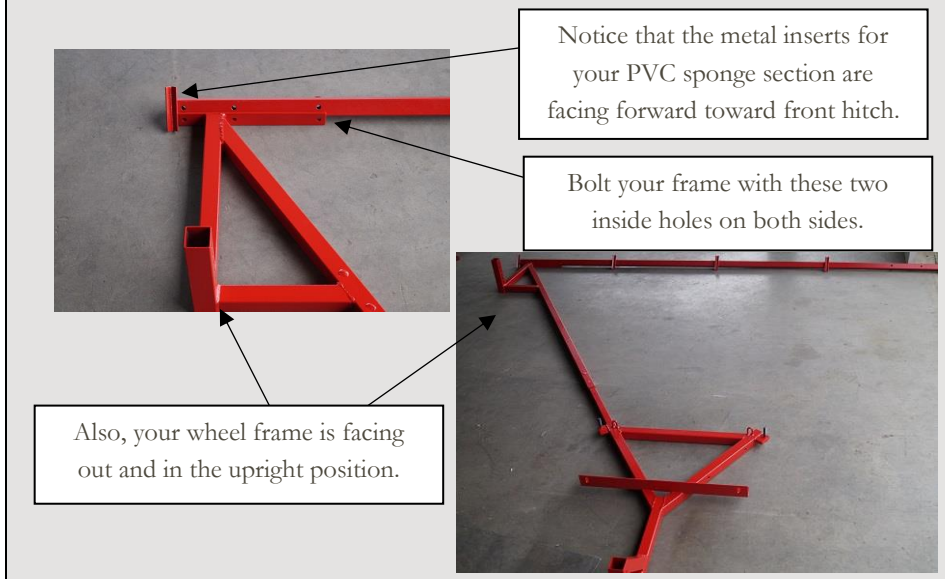

Step #4 Connect Your Wings

The left and right wings are secured by two of the 3/8" x 3" bolts (NB3830 QTY: 2) behind the 10' tool bar that you tightened in step #3 as pictured below (You may need to loosen up the nuts if you have already tightened them in step #3). **(U-joint should already be bolted to wing)**. Notice that the wheel brackets are in the upright position below.

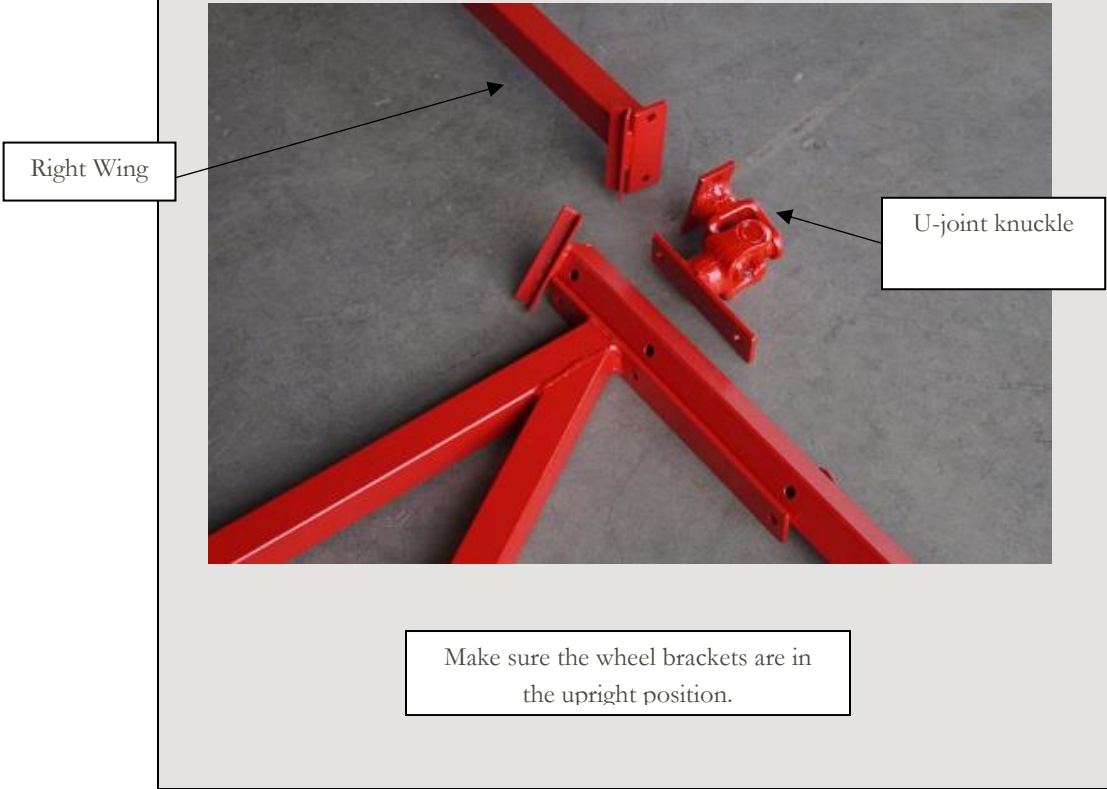

Step #5 Attach Wing Brace

Insert your wing brace cushions over each end of the wing brace brackets as pictured (WW2534 QTY: 4). Next, connect your wing brace bracket to your hitch in the position pictured using 1/2" Jam nuts (NB50NU QTY: 2 per wing brace, so 4 total).

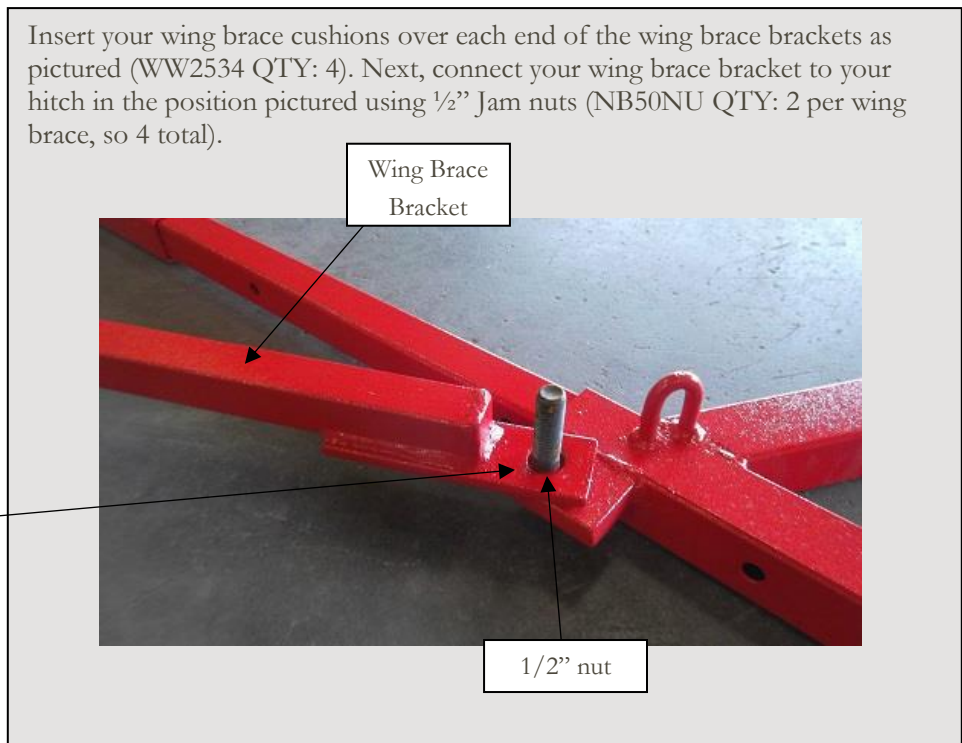

(Step #5 Continued)

Then, connect your wing brace to your toolbar with PTO pins (WW2520 QTY: 2) to secure your wing braces.

PTO pin
WW2520 Here.

Wing Brace
Bracket



Step #6 Insert the wheels



Insert the wheel legs (WW1400) (#8) into the sockets (#9) on both the inside right and inside left side of the frame as pictured below. Secure your wheel with 5 flat washers (NB75FL) per wheel and the 3/16" x 1 1/2" Lynch pin (WR4006) to lock your wheel in. Secure your wheel leg in at the preferred height with one PTO pin (WW2520) per wheel. **IMPORTANT:** Use a 1/2" x 1 1/4" bolt to tighten the wheel legs and hitch stand in the socket of each leg and hitch (NB5012 & NB50NU). This is necessary to remove rattle and sway when driving the machine at higher speeds.

(#9)

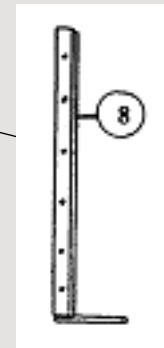
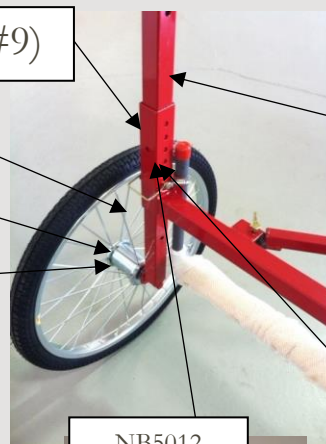

Similarly, attach your outside wheels with our outside Right Y Leg (WW1402) and Left Y Leg (WW1403). Secure your wheel with 5 flat washers (NB75FL) per wheel and the 3/16" x 1 1/2" Lynch pin (WR4006) to lock your wheel in. Secure your wheel leg in at the preferred height with one PTO pin (WW2520) per wheel. Use a 1/2" x 1 1/4" bolt to tighten the wheel legs and hitch stand in the socket of each leg and hitch (NB5012 & NB50NU). This is necessary to remove rattle and sway when driving the machine at higher speeds. **Note: your leg assembly should be facing outside. Thus, you can distinguish your left and right left leg by ensuring that your leg assembly wheel is facing outward as pictured above.**

Step #7 Attach your Stabilizer Bar

Attach your stabilizer bar (WW4004) to your inner wheel brackets, as pictured below, with the PTO pins provided (WW2520 QTY: 2).

WW2520



Step #8 Attach the Tank

Attach the tank and pump assembly (SPS014-WW) with tie down straps as pictured (SPS002). Note: **This is a 20 ft. pull type pictured, only use for this picture is to note how the tank is attached.**



Step #9 Connecting the Sponge Sections

The first step is to lay out each of the 30” sponge sections (WWTC30 QTY: 16) included in the kit, and connect them together as pictured with our PVC, “Tee” risers (WW2346-TC QTY: 19). This particular unit will have 3 different sponge sections. One section will be 10 ft., and two will be in 15 ft. increments (5 risers and 4 sponges per 10 ft. section, 7 risers and 6 sponges per 15 ft. section). Do not worry, it’s okay to end your boom with a, “Tee” since there is no chemical flow through the risers. The 15’ sections are for your wings.



IMPORTANT: DO NOT glue your sponge sections into your PVC, “Tees.” Hammer them together with a mallet (as shown in the picture below). It’s **very important** that you connect your sponge sections with the push to connect elbow facing up (as pictured) with the blue mark on your white caps facing forward from your boom, in the direction you will wipe, at the one o’clock position (as pictured). Notice that your push to connect elbow will be on the same side for each of your sponges across your boom (as pictured next page).

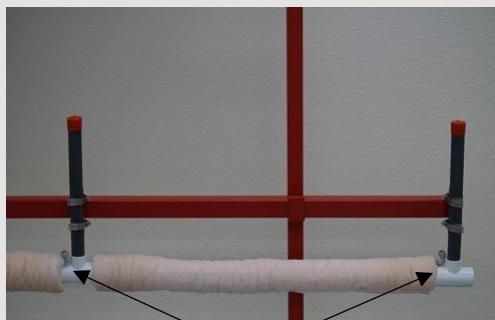
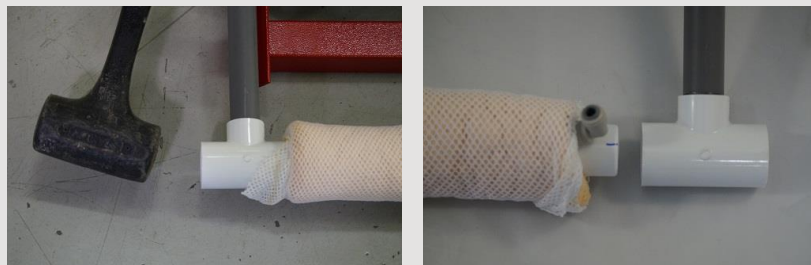

Push to Connect Elbow Facing Same Direction

Make sure, as you hammer in your elbow, that you get your sponge wet and hammer the elbow in until the edge of the cap reaches the center of the, “Tee.” After hammering in your risers, make sure you stretch your sponges out over your T-risers so that your boom is almost entirely covered by your sponges (Sponges must be wet to do this).

**Step #10
Attaching your
boom**

From there simply clamp your, “Tee” risers onto the metal angle iron tabs with the clamps included CL0016 (QTY: 38). Make sure that you clamp each, “Tee” riser at the same height to ensure that your sponge boom is level (as pictured next page).

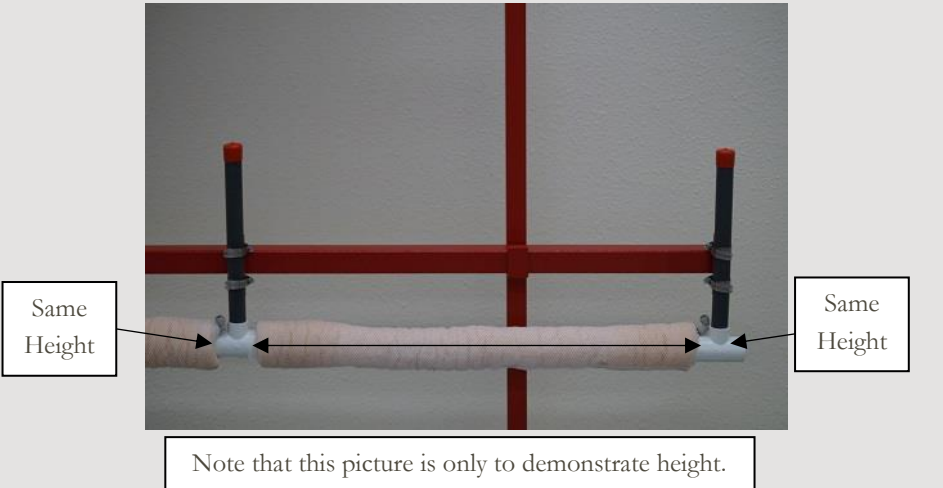

**Step #11 Mounting
your Manifold and
plumbing your
unit**

Your kit comes with two manifold system (WWTCM8P QTY: 2), which connect to your existing (not provided) equipment pump outlet. First, mount the provided Manifold systems (WWTCM8P QTY: 2) in a secure position equal distance apart along your sponge boom frame (note picture), as pictured, with the zip ties provided (NY108H QTY: 40).

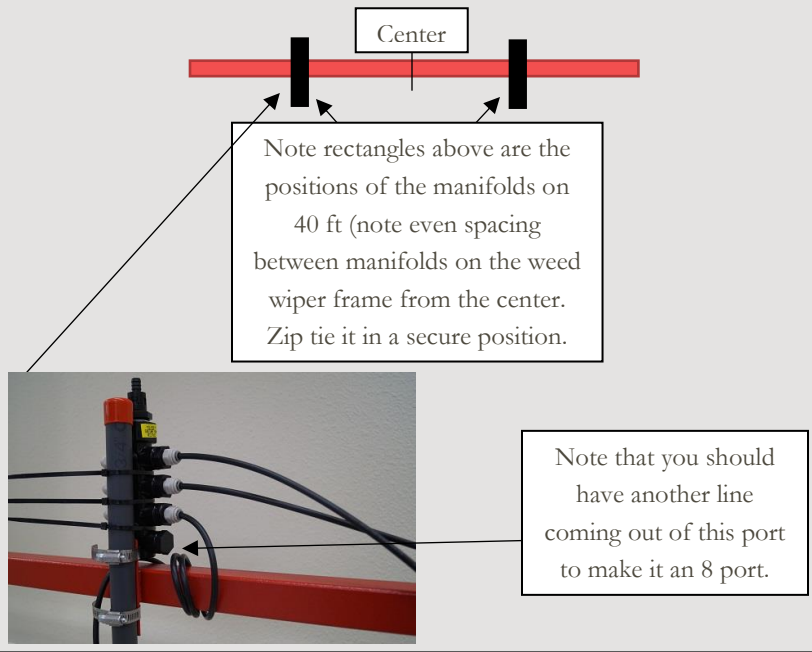

(Step #11 continued)

We provide the pump needed to power our weed wiper and the vinyl tubing (VL0038 QTY: 35 ft.) needed to run from your manifolds to your pump (since you have 2 manifolds. Cut your VL0038 1 ft. to your HT0038 tee hose connect and then cut the remaining tubing evenly to run out to each of your manifolds). Use our CL0916 clamps (QTY: 6) to secure your tubing to your manifolds, tee hose connect, and your pump outlet. Any extra 3/8" tubing may be coiled up. Now, connect your manifold inlet to your spray pump as pictured.



The manifold included has quick connectors to supply product to each of the 30" sponge section (in this case there are 16 ports). Cut your WW1215 1/4" black tubing evenly (Recommendation 13.5 ft. QTY: 16) to plumb from your manifold to your individual sponge sections. **It's extremely important that each sponge assembly is supplied with the same length of tubing to ensure equal chemical flow.** Any extra tubing for the closer sponge sections can just be coiled up or zip tied (View picture below for a visual). Do not over tighten the zip ties and pinch the tubing.

Simply push the tubing into the quick connectors on both your sponge section, and your manifold (as pictured). The only way to remove the tubing is to hold down the grey ring around push to connect, while pulling out the tubing.

Please note this picture shows a 6-port manifold only for your visual reference for your 8-port manifold.

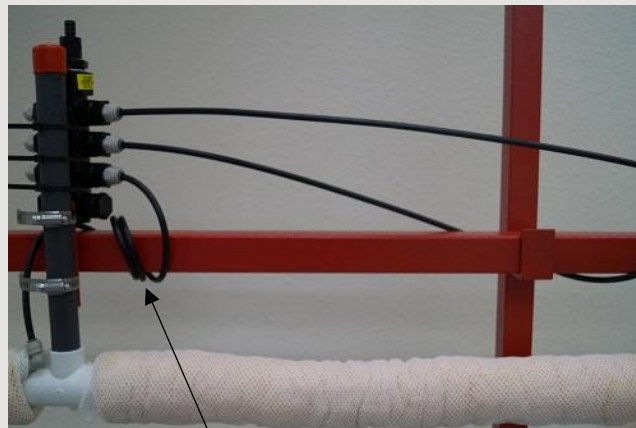

Coil up your tubing line for the sponges near the manifold as pictured.



Step #12 Connect your Wiper to your Hitch



Take your hitch stand and insert it into your front hitch insert in the picture below. Secure your hitch at the desired height with a PTO pin (WW2520). Don't forget to secure with a Jam Nut (NB5012 & NB50NU) used in step #6.

Insert your hitch into this slot.



Step #13 Using the weed wiper with your sprayer and installing the electrical wire harness

Install the wire harness (SPS117) according to the instructions included with the wire harness. Then, mount the switch in a position that can be reached by the operator.

When the pump is on, the chemical will be pumped into the PVC, through small holes, and into the sponge. This pump fed system will ensure quick filling of the sponges and instant shut off since the system is pressurized.

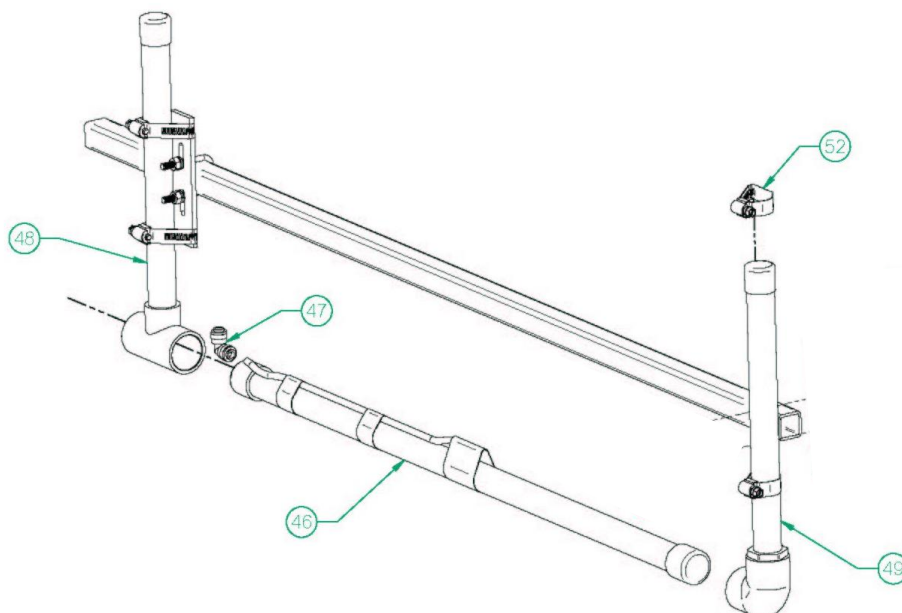

Operating Instructions

The Pull-Type Weed Wiper is a very effective contact herbicide applicator usually used to apply non-selective herbicides to weeds growing above crops. Proper set-up, adjustment, operation, and maintenance are essential to assure effective weed control while protecting the crop from herbicide damage.

Before You Start

1. Before you start using your sponge weed wiper in the field, always get the sponges wet with water prior to filling them with chemical. When sponges are dry, they are hard and less effective. Wetting your sponges with a garden hose before use, allows you to work out any dry spots before any application. We strongly recommend that you both fill them up with water, and ring them out before turning on your chemical flow.
 2. Next, we recommend that you run water through your tank to check your sponges for even feeding. Therefore, before filling the tank with chemicals, put water in your tank and turn on your pump until you see the sponges dripping. Watch for even dripping throughout the full length of the wiper. Unlike a conventional sprayer, you cannot see plugged nozzles on a wiper during operation. Always check for uniform feeding before heading out into the field.
 3. Once even feeding is attained, drain your product tank by removing the 3/8” supply tubing from the black filter. Squeeze the excess water from the sponges and fill the tank with the chemical solution following our mixing instructions below. Then turn on your pump until you see the sponges fully saturated (almost dripping), which typically will only take a few seconds. Once your sponges are saturated, you are ready to go!
-



Mixing Instructions

The most common product to use in a wiper is Glyphosate. The manufacturing label recommends a 33% mix rate, however, please follow **your** label for mix rates in a wiping applicator/contact herbicide applicator. It's important to remember that the ratio of herbicide to water can vary depending on the weeds to be controlled, the time of year, and the temperature. Contact your chemical field man or extension service for best herbicide mix and or surfactant for specific weed and crop conditions.

If you are trying to control Glyphosate resistance weeds follow the label for Paraquat. The label, in most states for controlling Palmer Amaranth, is listed at a 50% mix rate. However, **always follow the label.**

Field Adjustments

Adjust the height of the sponges to just above crop level and contact as much of the weed as possible, without contacting the crop.

Turn on the master on/off switch only when you believe you need more chemical, only for a short amount of time, and begin wiping at 5-7 MPH. Try to maintain a proper level of product in the sponges to maintain good coverage without dripping. While you are still unfamiliar with turning the pump on and off to adjust the chemical flow, it's usually better to set the wiper too wet and have a little dripping, rather than have it set too dry and have poor weed kill.

Folding Wings For Into Road Position

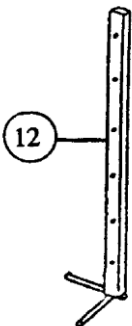

On a 40 foot model, the outside tires will need to be repositioned. Simply change the wheels to the opposite axle on the wheel leg (#12). Rotate the wheel leg in the socket in order to reposition the wheel. The wings will then trail directly behind the inside wheels. Fold back wing braces and let them rest on the folded back wings between the wheel legs. You may need to loosen the nuts where the wing brace attached to the front of the frame. (Previous page shows wing position).

Maintenance Requirements

Common Sponge Maintenance

The protective netting over the sponge is replaceable and is cheap to replace if you can replace the netting before the cellulose sponge is damaged. Therefore, we recommend that you check your sponges often for wear and tear.

If you need your sponge netting replaced, ask us for part number (WW2302). If you need your sponge replaced, ask us for part number (WW2301).

Storage Maintenance

Do not store the system over the off-season with chemical in the lines. A film will form on the tubing and can plug the small feedholes. Avoid this by flushing your system thoroughly with water at the end of the season. However, it's also advisable to flush the system with water and spray the sponges with water to remove chemical, which may cause the sponge to harden, after every use.

Check and clean the black filter, inside the tank, as needed. At the end of the season, store your weed wiper in a dry place, out of direct sunlight.

Policies and Information

Prices

Smucker MFG Inc. reserves the right to make changes in design, material, specifications, or price without notice or liability thereof. Prices are subject to change without notice, and orders will be processed according to prices in effect at the date of shipment unless notified otherwise.

Prices are FOB from Harrisburg, Oregon based on availability unless otherwise specified.

Shipments

United Parcel Service and common carrier will be prepaid and charged to the customer unless otherwise specified.

Call for quotes on special orders and orders outside the continental US.

Return Policy

No merchandise should be returned to Smucker Mfg., Inc. for credit unless accompanied by a return authorization number from our company. You will receive credit for the full amount of the return, if the merchandise is returned within 30 days of the invoice date. Any merchandise that is not returned within 30 days of the invoice date is subject to a restocking fee of 15%. Contact your Smucker dealer for return information.

Merchandise that has been special ordered cannot be returned for credit. Non-stock items returned for credit will be subject to vendor's return policy.

Damaged merchandise-shortages

Check merchandise immediately upon receiving shipment. Damages and shortages due to carrier damage must be claimed with the delivery carrier. Shortages must be claimed with Smucker Mfg. Inc. within five days of receiving the shipment.

Warranty for Distributed products

No one shall make any warranty, either implied or expressed, as to the performance, efficiency, or other capability that has not been stated in the manufacturer's guaranty.

The manufacturer's policy will determine any replacement of defective materials or workmanship, installation, use, and other causes beyond the replacement of defective parts.

Warranty for manufacturer's products

All products manufactured by Smucker Mfg. carry an industry leading guaranty, extending two full years from the date of purchase. Should there be any sort of defect or failure in that period with the unit or part(s), contact the Smucker Mfg. dealer that you purchased from for detailed information.

Contact

Please contact the dealer you purchased the product from for any questions concerning your purchase.