



WWTCKT30-SP

[User Manual]

Please read and follow the installation and operating instructions provided.

Table of Contents

| | | |
|------|--|---|
| I. | Introduction | 1 |
| II. | Installation Instructions | 2 |
| | Step #1 Connecting the Sponges | |
| | Step #2 Attaching your boom to your sprayer | |
| | Step #3 Plumbing your Weed Wiper | |
| | Step #4 Using the wiper with your sprayer and boom | |
| III. | Operating Instructions | 6 |
| | Before You Start | |
| | Mixing Instructions | |
| | Field Adjustments | |
| IV. | Maintenance Requirements | 8 |
| | Common Filter Maintenance | |
| | Operating At Freezing Temperatures | |
| V. | Policies and Information | 9 |

IMPORTANT:

**PLEASE RETURN YOUR OWNERS REGISTRATION CARD WITHIN THE NEXT 10 DAYS TO
ACTIVATE YOUR WARRANTY.**

INTRODUCTION

Congratulations on your purchase of a Smucker Super Sponge® Weed Wiper!

The Super Sponge® is a lightweight, durable, herbicide applicator. Our sponges are designed to apply the maximum amount of product to the target weeds without any drift. The sponge applicators are made of industrial-strength, crusted sponge that stay saturated with chemical to wipe directly onto weeds. Our sponge weed wiper and top crop kits are applicators. Smucker Manufacturing makes no guarantee of any and all chemical use through the sponge application. Please read all chemical labeling concerning the weed wiper instructions.

The Super Sponge® has proven to be a quick and efficient way to wipe out weeds in your crops in many independent studies and we are confident you will be pleased with the results. We value our customers, and we would appreciate any input or comments you may have regarding your new Super Sponge® wiper.

You will find a Smucker Catalog with all of the replacement parts and diagrams included in the Weed Wiper section of the catalog. You can also visit our smuckermfg.net website page for weed wiper parts information, to find out which part you need. If you still have questions, give us a call and we can even help you locate your closest Smucker dealer.

Also, visit www.smuckermfg.net or ask your dealer about the other product lines we offer. We offer premium products at an affordable price. Take a look at our Foam Markers, Calf Warmers, and VisionWorks camera systems for farm equipment on our website.

www.smuckermfg.net

www.redweeder.com

www.visionworkscameras.com

Scan QR codes below with your smart phone

Mobile website for VisionWorks Cameras

Smucker Mobile website



Installation Instructions

Thank you for purchasing a Top Crop Weed Wiper kit. Please follow the directions provided carefully. Remember that the weed wiper model you have purchased is our kit model. Our kit model provides our end-users an extremely flexible and cost efficient way to get rid of their weed problems. With that being said, each kit will be fully customizable to your equipment application. Therefore, our manuals are as detailed as they can be considering each application will vary.

Please refer to your Diagram on Page #5 and your Parts Inventory Sheet when installing your Weed Wiper.

Step #1 Connecting the Sponge Sections

The first step is to lay out each of the 30” sponge sections (WWTC30 QTY: 15) included in the kit, and connect them together as pictured with our PVC, “Tee” (WW2346-TC QTY: 24). **You may need to split your sponge sections up if you have wings on your equipment application.** Do not worry, it’s okay to end your boom with a, “Tee” since there is no chemical flow through the risers.

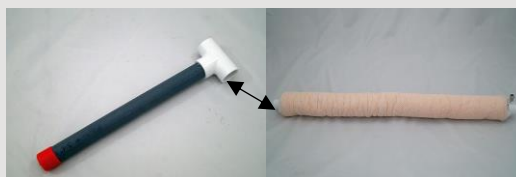

IMPORTANT: DO NOT glue your sponge sections into your PVC, “Tees.” Hammer them together with a mallet (as shown in the picture below). It’s **very important** that you connect your sponge sections with the push to connect elbow facing up (as pictured) with the blue mark on your white caps facing forward from your boom, in the direction you will wipe, at the one o’clock position (as pictured). Notice that your push to connect elbow will be on the same side for each of your sponges across your boom (as pictured next page).

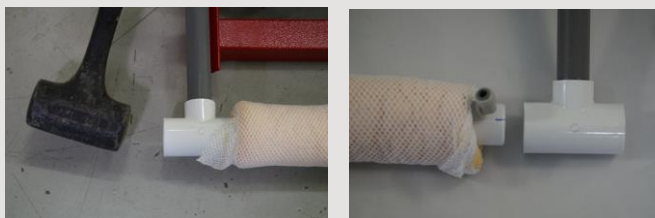

Make sure, as you hammer in your elbow, that you get your sponge wet and hammer the elbow in until the edge of the cap reaches the center of the, “Tee.” After hammering in your risers, make sure you stretch your sponges out over your T-risers so that your boom is almost entirely covered by your sponges (Sponges must be wet to do this).

(Step #1 Continued)



Make sure, as you hammer in your elbow, that you get your sponge wet and hammer the elbow in until the edge of the cap reaches the center of the, “Tee.” After hammering in your risers, make sure you stretch your sponges out over your T-risers so that your boom is almost entirely covered by your sponges (Sponges must be wet to do this).

Step #2 Attaching your boom to your sprayer

Use the WW Mounting Brackets w/ U Bolts provided in this kit (WW2344 QTY: 24) to mount your Wiper to your sprayer. Attach your metal brackets every 30” and you can also offset the risers to overlap and make the 30” sponge sections come out even at the end of your booms (as pictured below), or at a place where your boom goes into a cradle. Take off the red cap and slide the riser up through the square tubing bracket. Then, tighten your, “Tee” in with the jam nut.

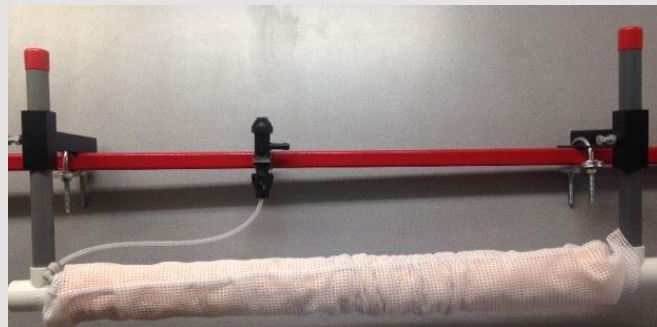

Make sure that your risers are set at the same height throughout your sponge section to assure level weed wiping (as pictured above).

Top view of the offset overlap.

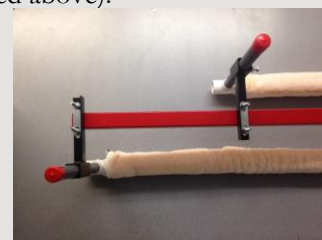

Step #3 Plumbing Your Weed Wiper

(Step #3 Continued)

Attach the TeeJet nozzle fitting (SS-QJ98588-1/4 QTY: 15) to the spray nozzles that are closest to each push to connect fitting on each sponge section (total of 15 push to connect fittings). Note the pictures below for directions.

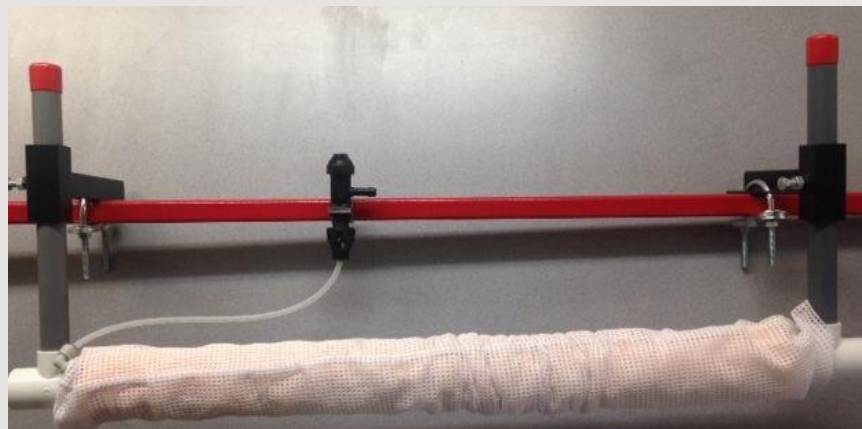
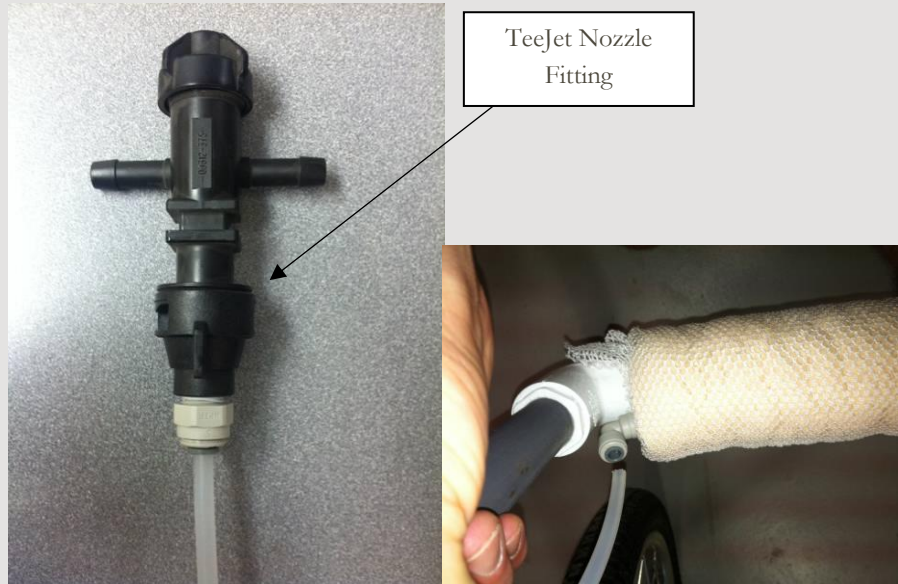

Any spray nozzles on your boom that are not in use, can either be switched to the off position, or capped with our cap and gasket shut off (SS-19843NYR QTY: 6). Attach a short piece of black tubing from your 1/4" tubing roll (WW1215 QTY: 30 ft.), from the TeeJet fitting to the inlet of the sponge section. The sponges and spray nozzles have an easy to use push to connect fitting that can only be released by pressing on the grey ring on the fitting, while pulling out the tubing.

Step #4 Using the weed wiper with your sprayer and boom

It's very important to have a cleanable in-line filter on your sprayer to prevent small particles from plugging up the small outlets inside the sponge feed tubes (as pictured). Below we have pictured our in-line filters for purchase.



FM1032



FM0138

Make sure that you have a way to turn the pump on and off, because you will not run the pump continuously while using your weed wiper. This is usually done with a master on and off switch on your pump or through your boom section controls (depending on how you set up your plumbing). When the pump is on, the chemical will be pumped into the PVC, through small holes, and into the sponge. This pump fed system will ensure quick filling of the sponges and instant shut off since the system is pressurized.

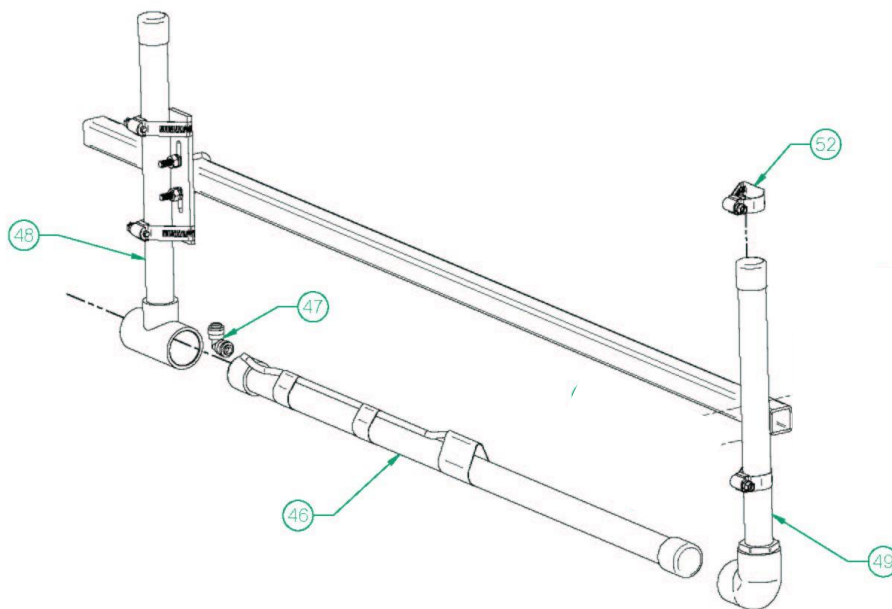

Operating Instructions

The TOP CROP Weed Wiper is a very effective contact herbicide applicator usually used to apply non-selective herbicides to weeds growing above crops. Proper set-up, adjustment, operation, and maintenance are essential to assure effective weed control while protecting the crop from herbicide damage.

Before You Start

1. Before you start using your sponge weed wiper in the field, always get the sponges wet with water prior to filling them with chemical. When sponges are dry, they are hard and less effective. Wetting your sponges with a garden hose before use, allows you to work out any dry spots before any application. We strongly recommend that you both fill them up with water, and ring them out before turning on your chemical flow.
 2. Next, we recommend that you run water through your product tank to check your sponges for even feeding. Therefore, before filling the tank with chemicals, put water in your tank and turn on your pump until you see the sponges dripping. Watch for even dripping throughout the full length of the wiper. Unlike a conventional sprayer, you cannot see plugged nozzles on a wiper during operation. Always check for uniform feeding before heading out into the field.
 3. Once even feeding is attained, drain your product tank by removing the 3/8" supply tubing from the black filter. Squeeze the excess water from the sponges and fill the tank with the chemical solution following our mixing instructions below. Then turn on your pump until you see the sponges fully saturated (almost dripping), which typically will only take a few seconds. Once your sponges are saturated, you are ready to go!
-

Mixing Instructions

The most common product to use in a wiper is Glyphosate. The manufacturing label recommends a 33% mix rate, however, please follow **your** label for mix rates in a wiping applicator/contact herbicide applicator. It's important to remember that the ratio of herbicide to water can vary depending on the weeds to be controlled, the time of year, and the temperature. Contact your chemical field man or extension service for best herbicide mix and or surfactant for specific weed and crop conditions.

If you are trying to control Glyphosate resistance weeds follow the label for Paraquat. The label, in most states for controlling Palmer Amaranth, is listed at a 50% mix rate. However, **always follow the label.**

Field Adjustments

Adjust the height of the sponges to just above crop level and contact as much of the weed as possible, without contacting the crop.

Turn on the master on/off switch only when you believe you need more chemical, only for a short amount of time, and begin wiping at 5-7 MPH. Try to maintain a proper level of product in the sponges to maintain good coverage without dripping. While you are still unfamiliar with turning the pump on and off to adjust the chemical flow, it's usually better to set the wiper too wet and have a little dripping, rather than have it set too dry and have poor weed kill.

Maintenance Requirements

Common Sponge Maintenance

The protective netting over the sponge is replaceable and is cheap to replace if you can replace the netting before the cellulose sponge is damaged. Therefore, we recommend that you check your sponges often for wear and tear.

If you need your sponge netting replaced, ask us for part number (WW2302). If you need your sponge replaced, ask us for part number (WW2301).

Storage Maintenance

Do not store the system over the off-season with chemical in the lines. A film will form on the tubing and can plug the small feedholes. Avoid this by flushing your system thoroughly with water at the end of the season. However, it's also advisable to flush the system with water and spray the sponges with water to remove chemical, which may cause the sponge to harden, after every use.

Check and clean the black filter as needed. At the end of the season, store your weed wiper in a dry place, out of direct sunlight.

Policies and Information

Prices

Smucker MFG Inc. reserves the right to make changes in design, material, specifications, or price without notice or liability thereof. Prices are subject to change without notice, and orders will be processed according to prices in effect at the date of shipment unless notified otherwise.

Prices are FOB from Harrisburg, Oregon based on availability unless otherwise specified.

Shipments

United Parcel Service and common carrier will be prepaid and charged to the customer unless otherwise specified.

Call for quotes on special orders and orders outside the continental US.

Return Policy

No merchandise should be returned to Smucker Mfg., Inc. for credit unless accompanied by a return authorization number from our company. You will receive credit for the full amount of the return, if the merchandise is returned within 30 days of the invoice date. Any merchandise that is not returned within 30 days of the invoice date is subject to a restocking fee of 15%. Contact your Smucker dealer for return information.

Merchandise that has been special ordered cannot be returned for credit. Non-stock items returned for credit will be subject to vendor's return policy.

Damaged merchandise-shortages

Check merchandise immediately upon receiving shipment. Damages and shortages due to carrier damage must be claimed with the delivery carrier. Shortages must be claimed with Smucker Mfg. Inc. within five days of receiving the shipment.

Warranty for Distributed products

No one shall make any warranty, either implied or expressed, as to the performance, efficiency, or other capability that has not been stated in the manufacturer's guaranty.

The manufacturer's policy will determine any replacement of defective materials or workmanship, installation, use, and other causes beyond the replacement of defective parts.

Warranty for manufacturer's products

All products manufactured by Smucker Mfg. carry an industry leading guaranty, extending two full years from the date of purchase. Should there be any sort of defect or failure in that period with the unit or part(s), contact the Smucker Mfg. dealer that you purchased from for detailed information.

Contact

Please contact the dealer you purchased the product from for any questions concerning your purchase.